

Basic measurements Decibel sliding door (for non standard size, see page 3)

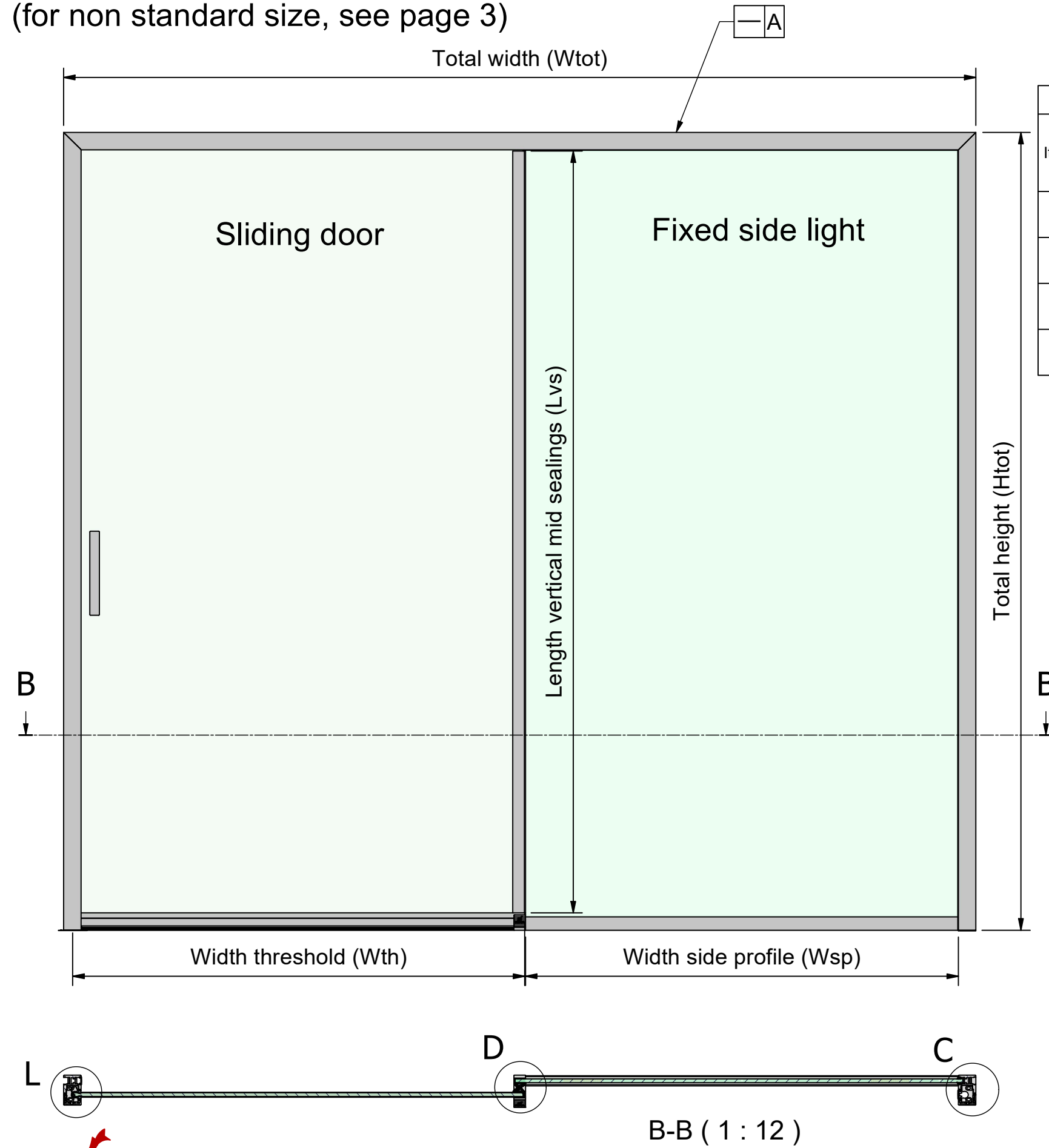

This instruction show a sliding door on the left and a fixed light on the right. The sliding door can also be mounted the other way around, with the door on the right and the fixed light on the left.

Table standard sizes										
Item number	Wtot	Htot	Wsp	Wth	Lvs	Door width	Door height	Fixed side light width	Fixed side light height	Apperance
865330	2390	2090	1134	1184	1996	1180	2037	1173	2041	Natural anodized
865331	2390	2090	1134	1184	1996	1180	2037	1173	2041	Black RAL 9005 gloss 30
865332	2090	2090	984	1034	1996	1030	2037	1023	2041	Natural anodized
865333	2090	2090	984	1034	1996	1030	2037	1023	2041	Black RAL 9005 gloss 30

Recommended glass:

For sound reduction up to 32 dB: Stratophone 10.76 mm laminated glass
 For sound reduction up to approx. 28 dB: Tempered 10 mm glass or standard 10.76 mm laminated glass

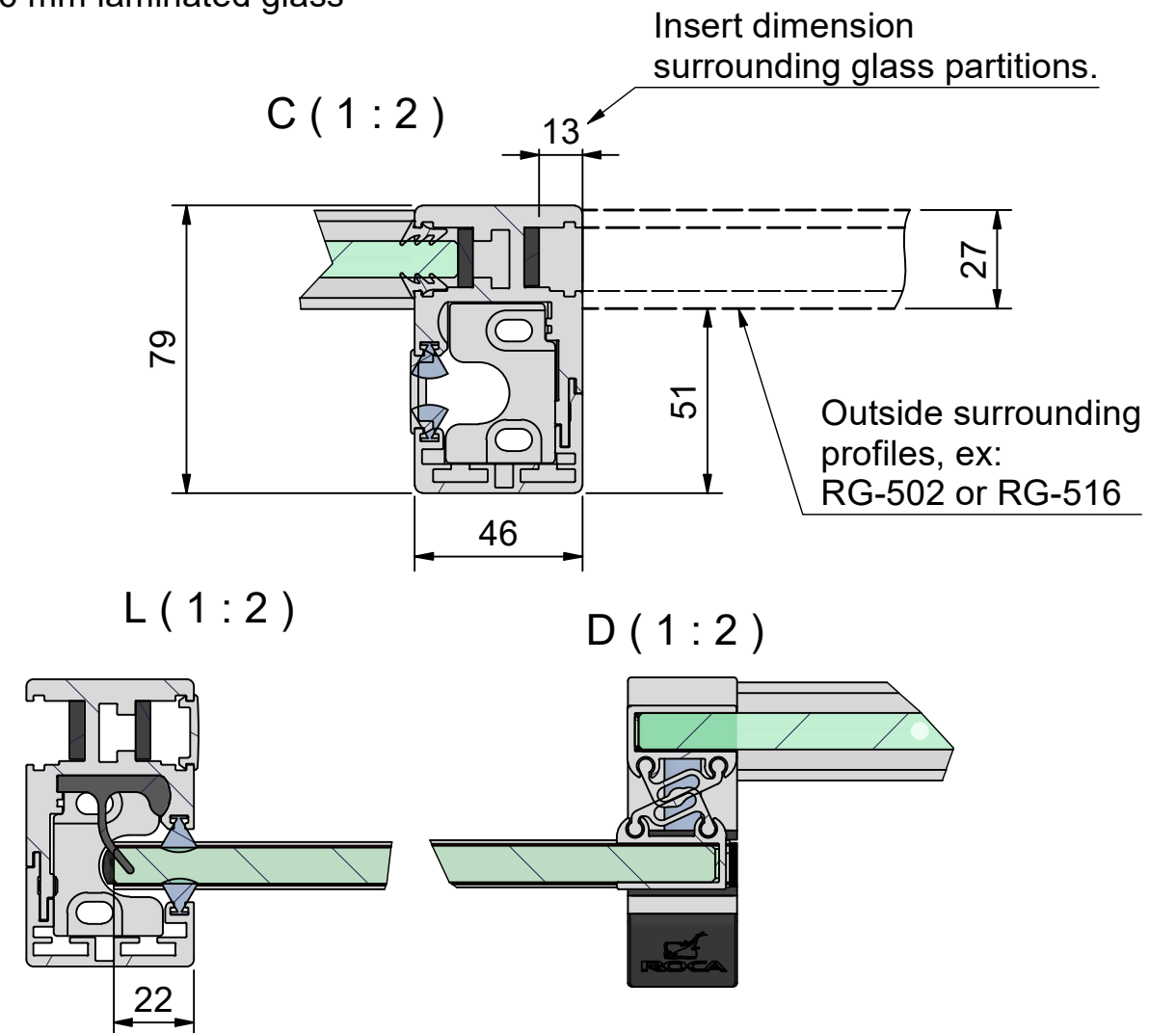

Clear opening measurements Decibel sliding door
 (for non standard size, see page 3)

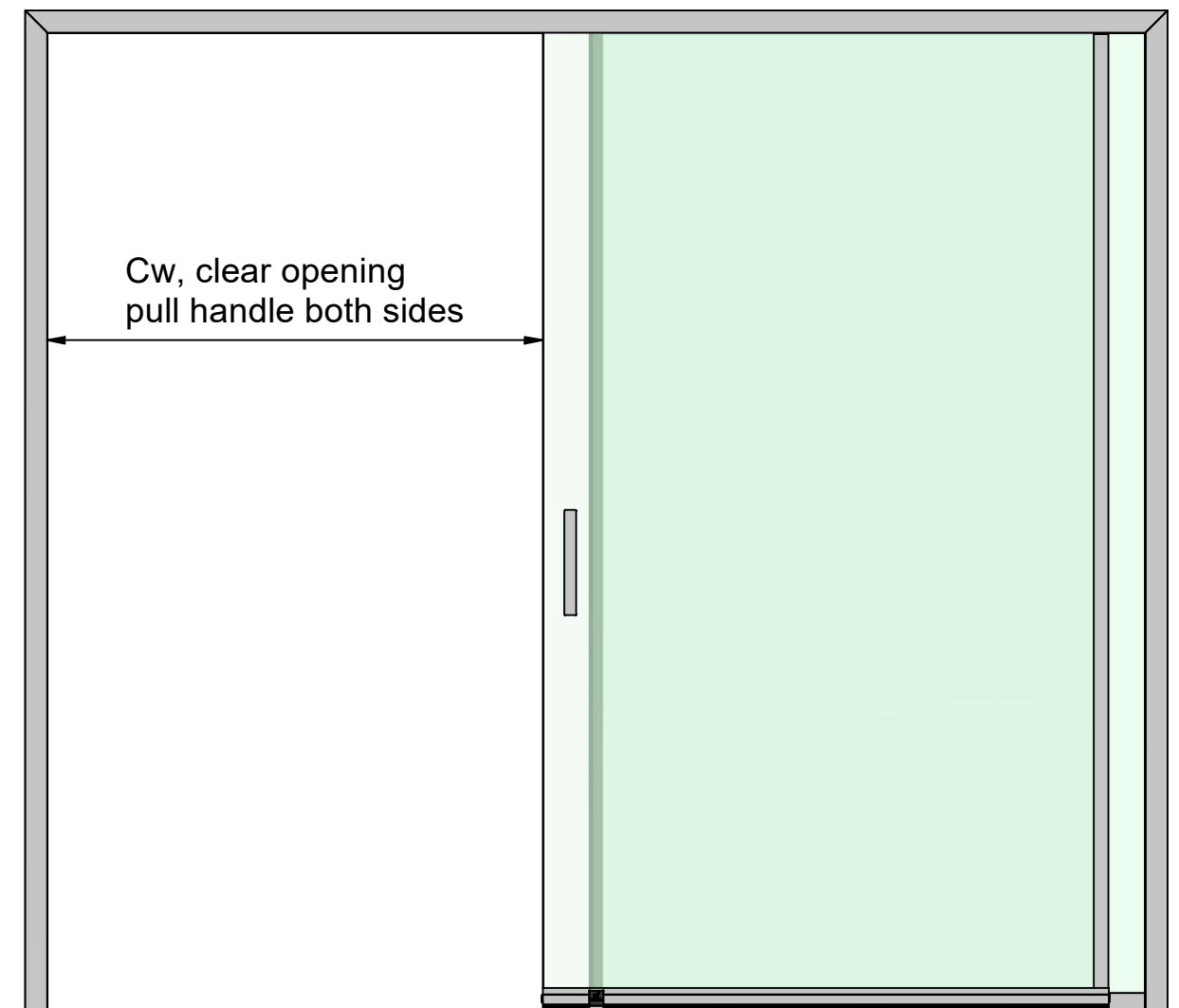
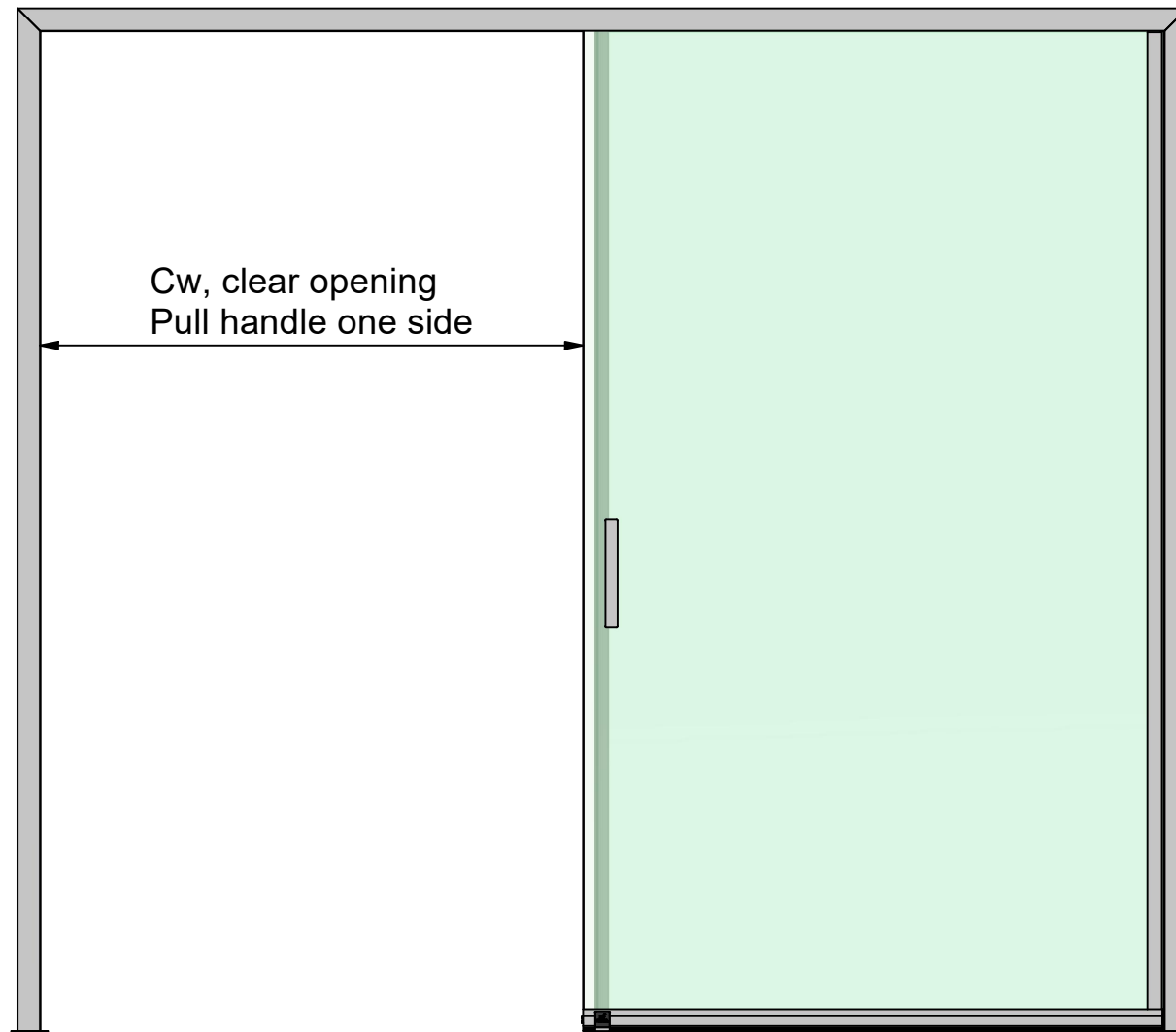
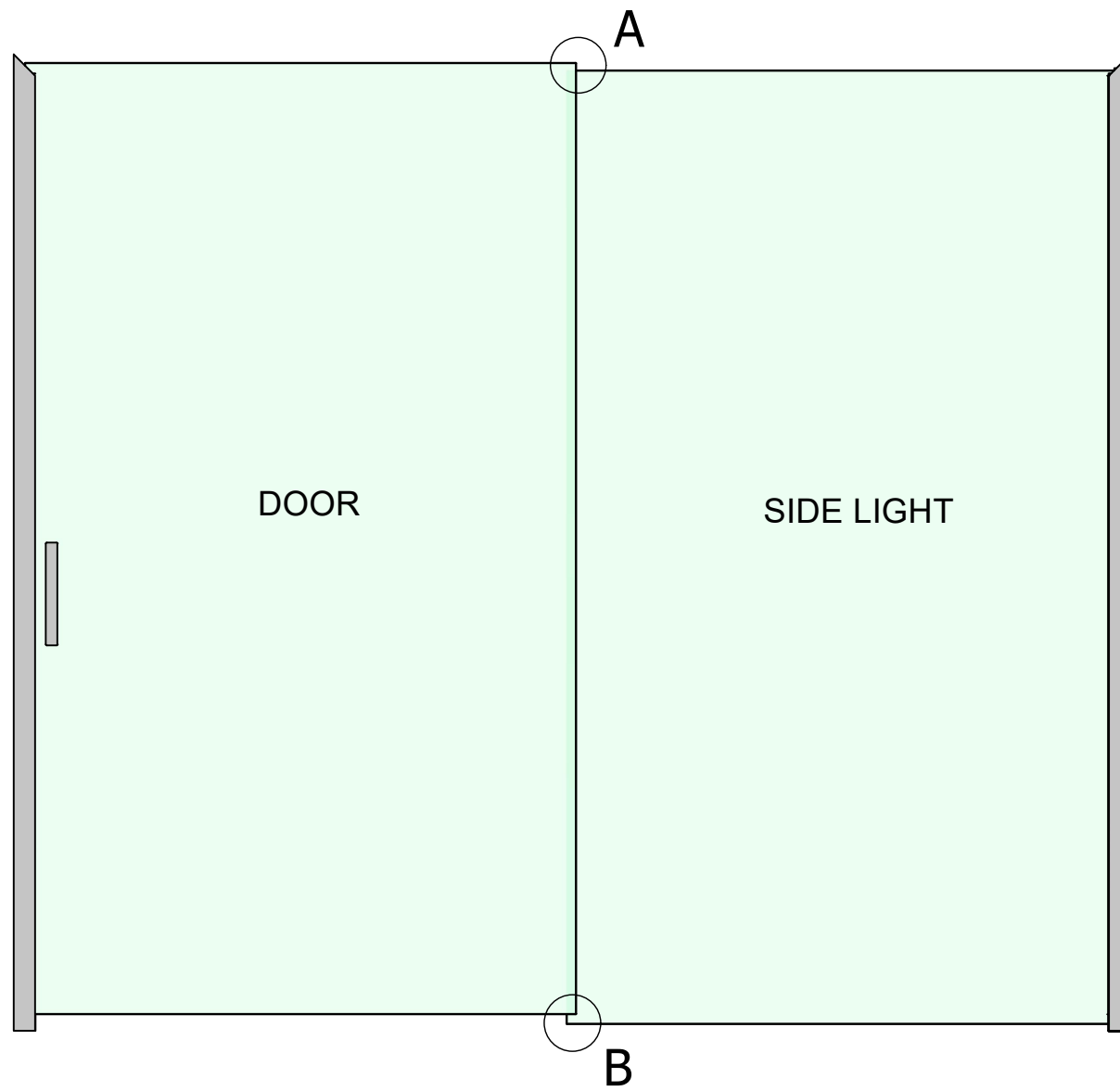

Table Cw standard sizes		
Wtot	Cw (pull handle outside)	Cw (pull handle both sides)
2390	1110	~1030*
2090	960	~880*

* depending on type of pull handle, see page 3



Decibel sliding door - glass heights



A (1:1)

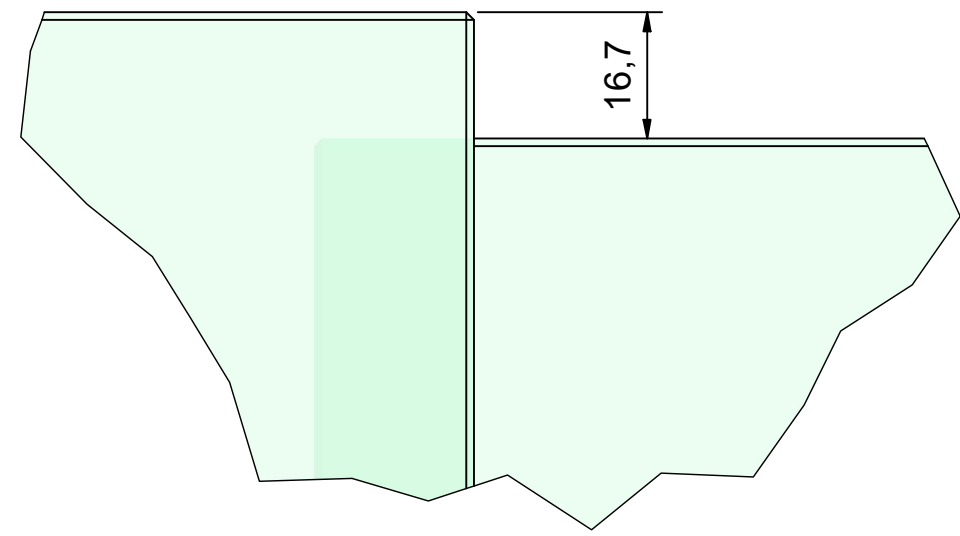

B (1:1)

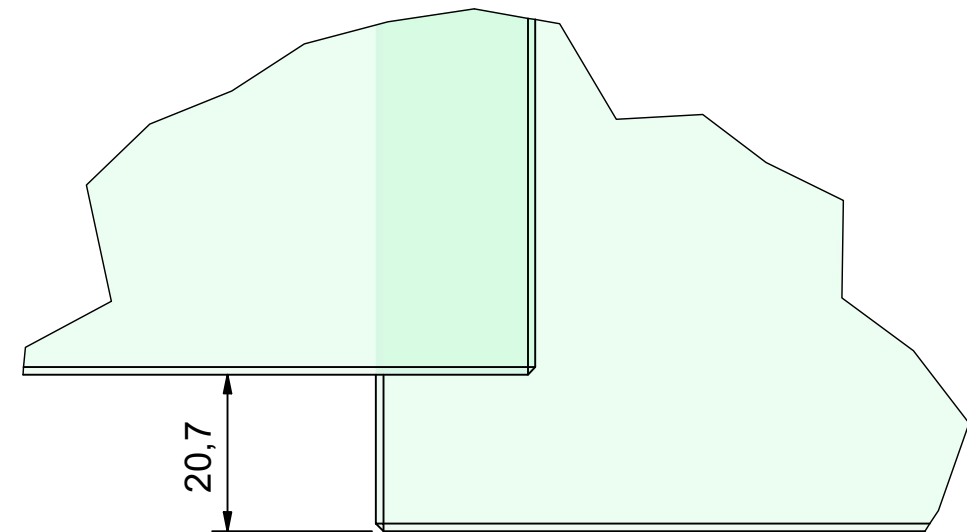

Calculations glass and profile sizes.

Door glass

$$Hd = H_{tot} - 53$$

$$Wd = (W_{tot} - 37) / 2 + 3,5$$

$$\text{ex. modul } 2390 \times 2090 \quad Wd = 1180 \quad Hd = 2037$$

$$\text{ex. modul } 2090 \times 2090 \quad (2090 - 37) / 2 + 3,5 = Wd = 1030$$

Note! Max door weight is 65 kg

Width Aut threshold

$$Wd + 4\text{mm}$$

$$\text{ex. } 2390 \quad \text{Threshold} = 1184$$

$$\text{ex. } 2090 \quad \text{Threshold} = 1034$$

Side light (sl)

$$Hsl = H_{tot} - 49$$

$$Wsl = (W_{tot} - 37) / 2 - 3,5$$

$$\text{ex. modul } 2390 \times 2090 \quad Wsl = 1173 \quad Hsl = 2041$$

$$\text{ex. modul } 2090 \times 2090 \quad Wsl = 1023$$

Inner side profile RG-502 (sp)

$$\text{Width inside floor profile } Wsp = Wsl - 39$$

$$\text{ex. } W_{tot} = 2390 \quad Wsp \text{ (side profile)} = 1134$$

$$\text{ex. } W_{tot} = 2090 \quad Wsp = 984$$

Length vertical mid sealing

(u-profile with rubber)

$$Lvs = H_{tot} - 94$$

$$\text{ex. modul } 2090$$

$$2090 - 94 = 1996$$

Clear opening (Cw)

46% of W_{tot} minus pull handle

$$\text{ex. modul } 2390 = 1110$$

$$\text{ex. modul } 2090 = 960$$

Clear opening are reduced depending on the choice of pull handle. Example:

- Insertion in frame 22 mm
- Distance frame to pull handle to avoid pinching fingers approx. 30 mm
- The diameter of the pull handle approx. 25 mm
- Distance pull handle to vertical center profiles so as not to pinch fingers approx. 30mm.

In total, this setup takes approx. 110 mm reduction in clear opening.

